

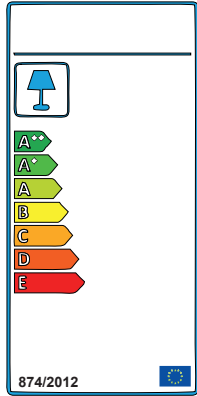

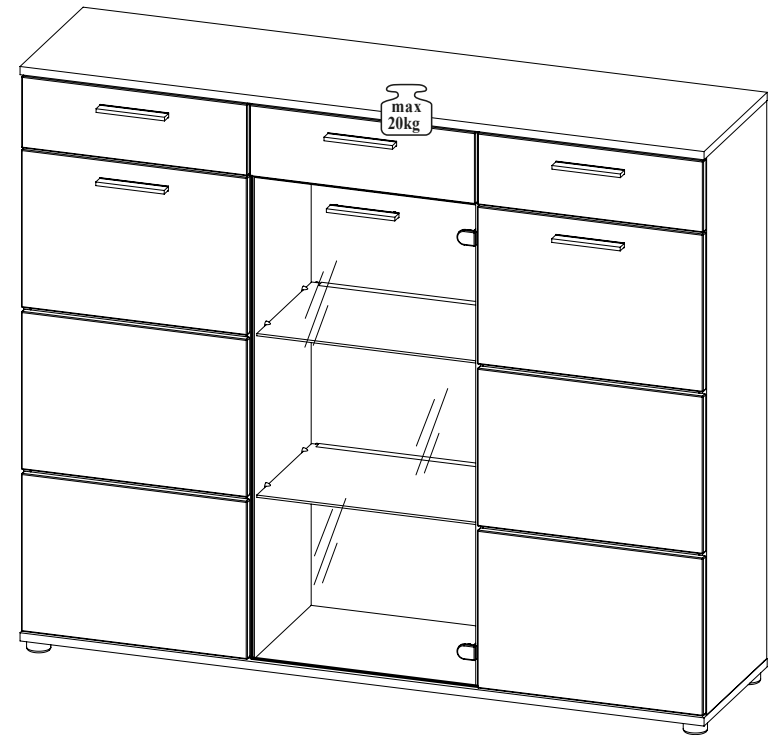

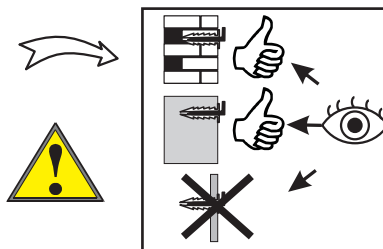

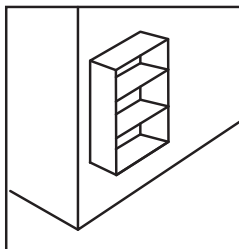

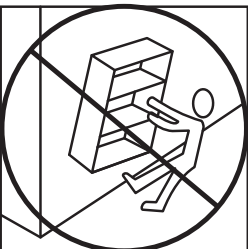
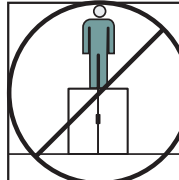
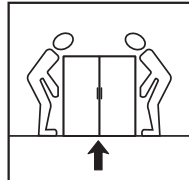
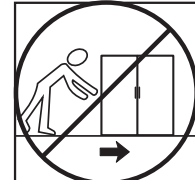
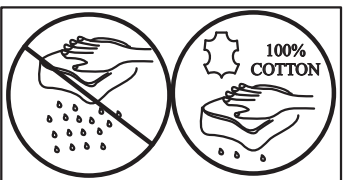
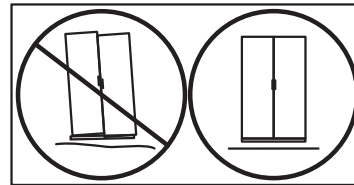
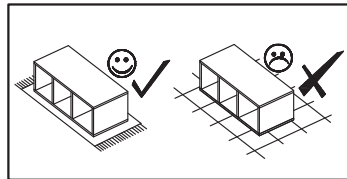
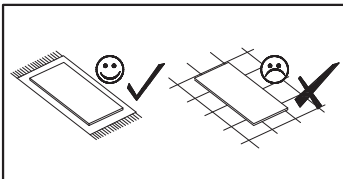
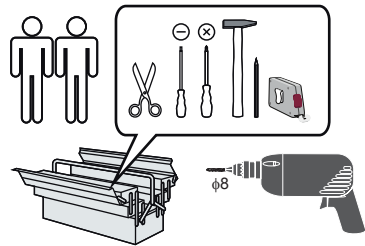
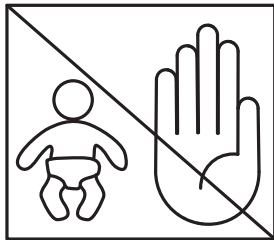

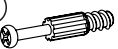







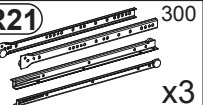



<http://www.bega-gruppe.de>

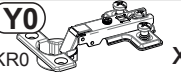
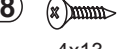

BG	Bulgarisch	Български
CS	Tschechisch	čeština
DA	Dänisch	Dansk
DE	Deutsch	Deutsch
ET	Estnisch	Eesti
EL	Griechisch	ελληνικά
EN	Englisch	English
ES	Spanisch	español
FR	Französisch	Français
FI	Finnisch	suomalainen
HR	Kroatisch	hrvatski
HU	Ungarisch	magyar
IT	Italienisch	Italiano
LV	Lettisch	Latvijas
LT	Litauisch	Lietuvos
NL	Niederländisch	Nederlands
PL	Polnisch	Polski
PT	Portugiesisch	português
RO	Rumänisch	român
SK	Slowakisch	slovenský
SL	Slowenisch	slovenščina
SV	Schwedisch	Svenska

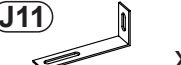

- B1**   $\phi$  8x28 x34
- T1**  x28
- M1**  x22
- C2**   $\phi$  20 x8
- M12**  x6
- B4**  x12
- W14**  x24
- F1**  x16
- P2**  3x16 x40
- J23**  x20
- R21**  300 x3
- E4**  6,0x8 x18
- P10**  3x13 x18
- S3**  3,5x13 x6

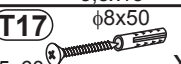
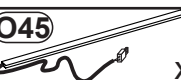
- Y0**  KRO x6
- S8**  \* 4x13 x12
- X9s**  x2
- F10**  x6
- P17**  \* 4x20 x6
- U42b**  x6
- P4**  \* 4x25 x10
- G4**  x2
- P16**  \* 4x16 x2
- J11**  x2
- P13**  \* 3,5x13 x4
- T17**   $\phi$ 8x50 5x60 x2
- O45**  x6
- O51**  x1

Nr	Ausmaß	St	Colli
1	471 330	5 4	1
2	480 330	5 2	1
3	1056 495	4 1	3
4	1223 362	15 1	3
5	1223 362	15 1	3
6	1223 342	15 1	3
7	1223 342	15 1	3
8	476 98	15 2	3
9	485 82	15 1	2
10	427 100	12 2	2
11	436 100	12 1	2
12	1499 380	18 2	2
13	300 100	12 3	2
14	300 100	12 3	2
15	495 157	16 1	1
16	495 157	16 1	1
17	495 157	16 1	1
18	346 495	16 2	1
19	346 495	16 1	1
20	346 495	16 1	1
21	346 495	16 1	1
22	346 495	16 1	1
23	472 70	4 4	1
24	1237 499	2 1	3
25	438 299	2 2	1
26	447 299	2 1	2
27	1237 490	2 2	3

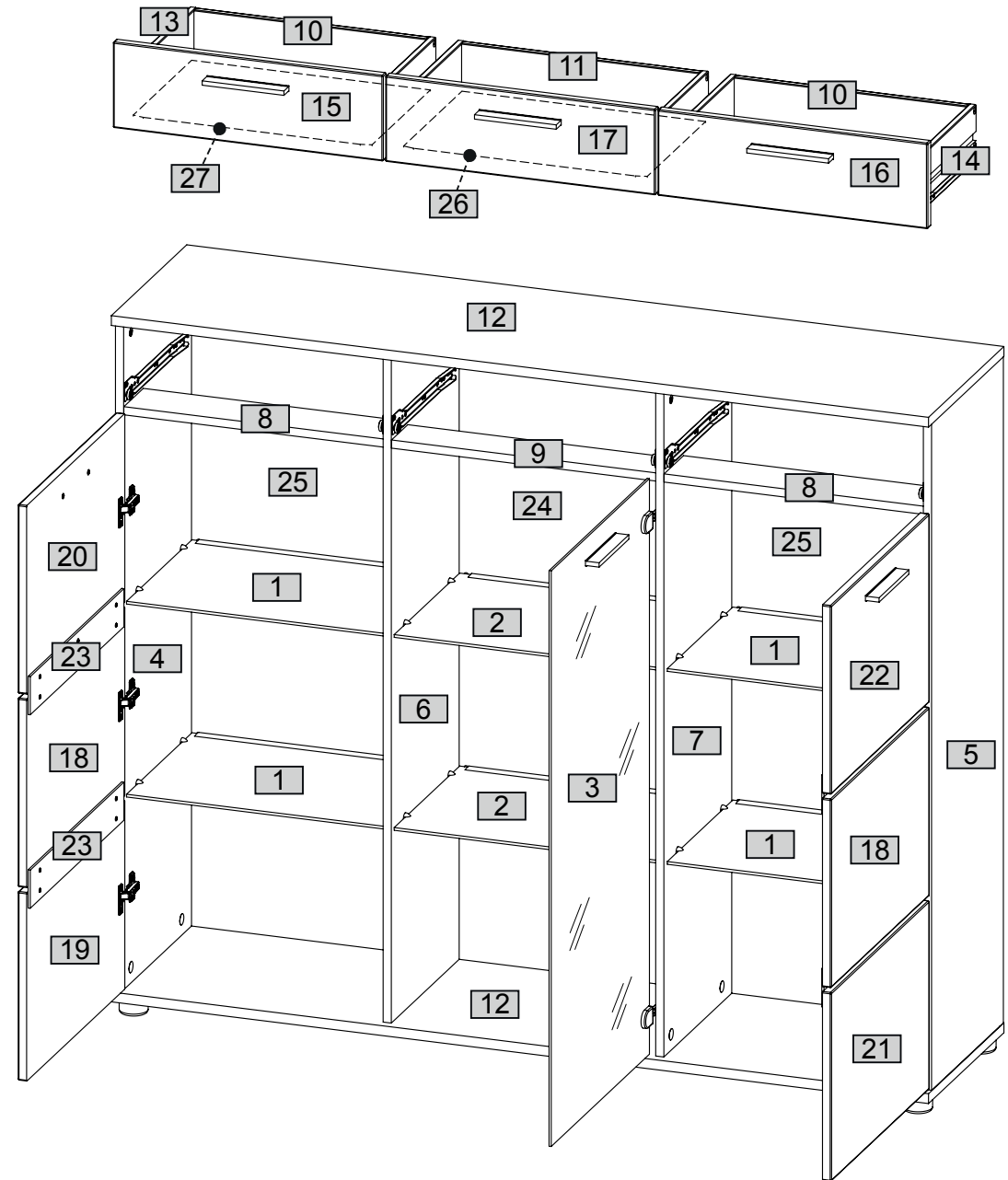

1

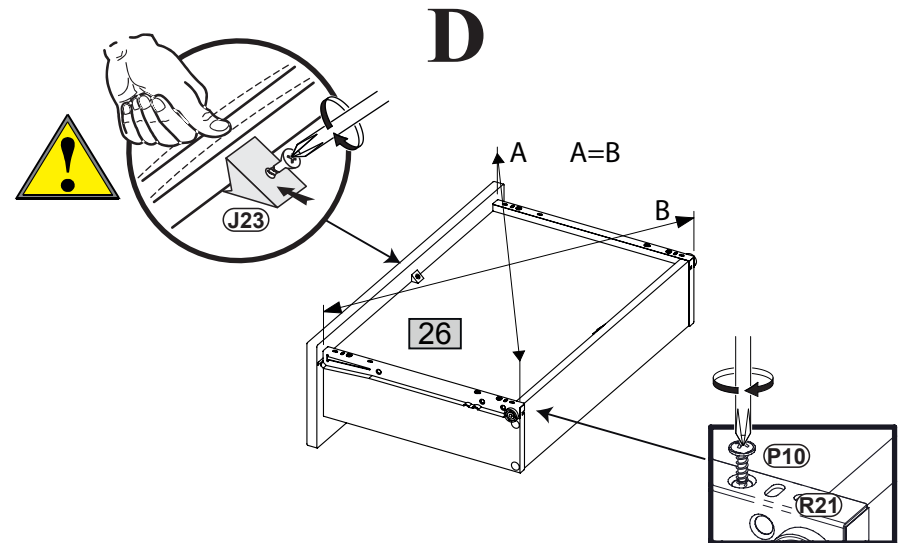
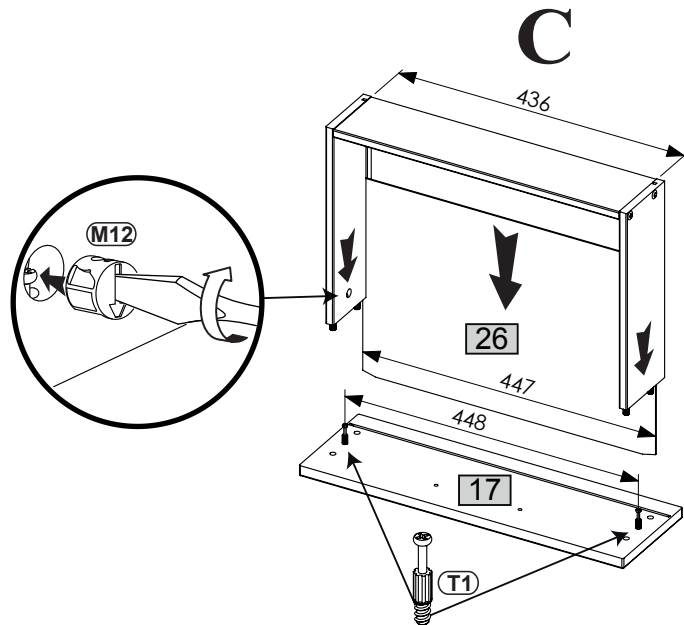
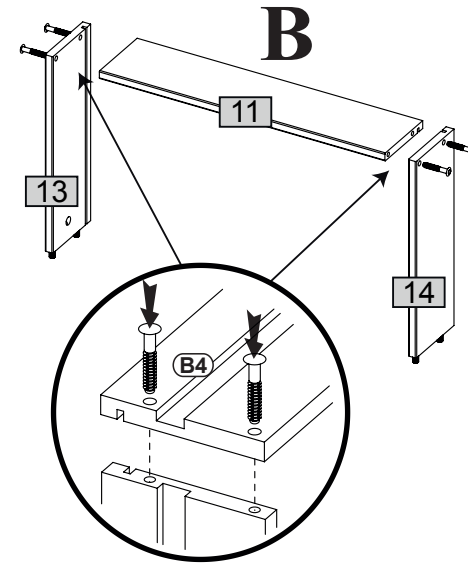
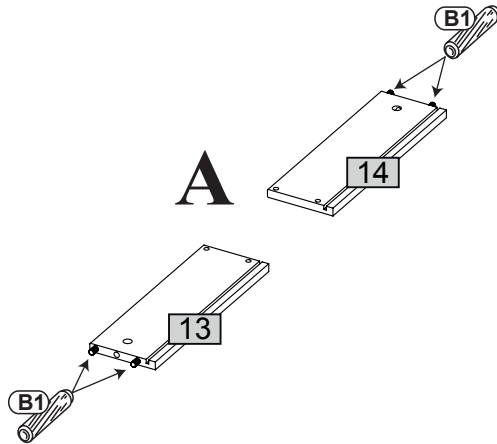
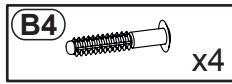
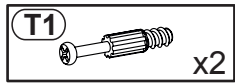
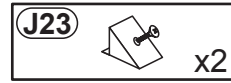
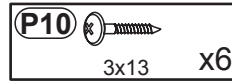
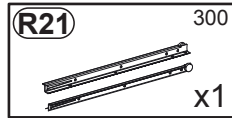
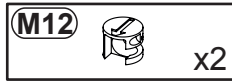
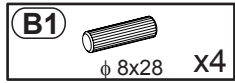

2

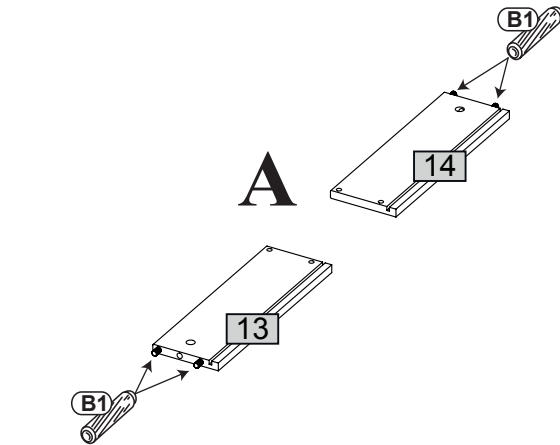
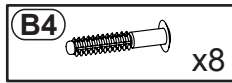
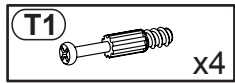
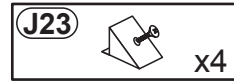
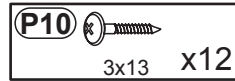
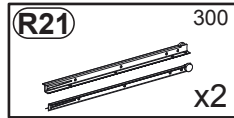
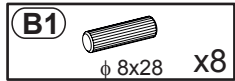

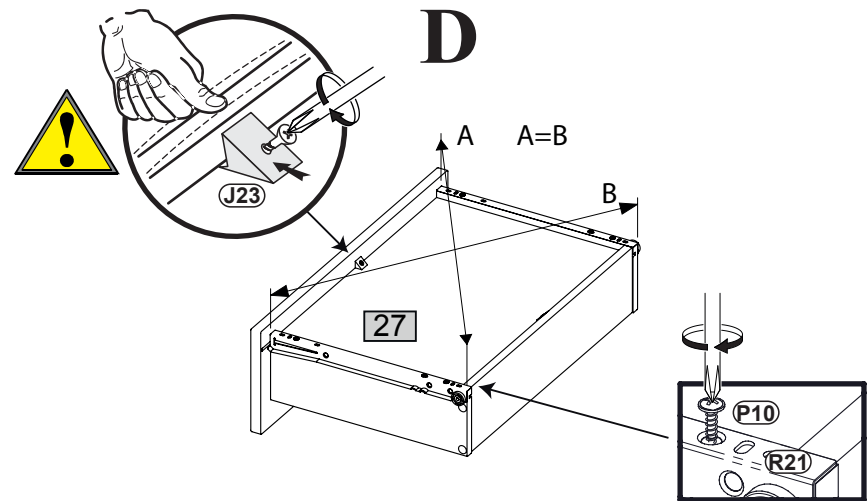
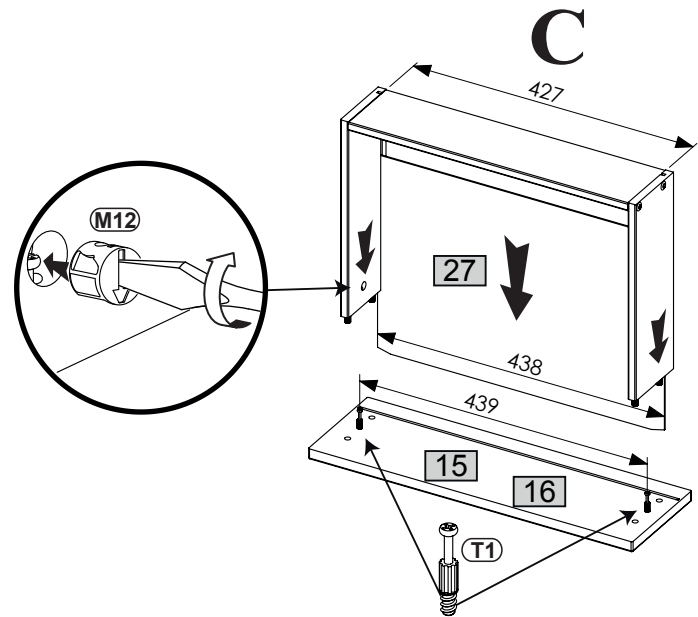
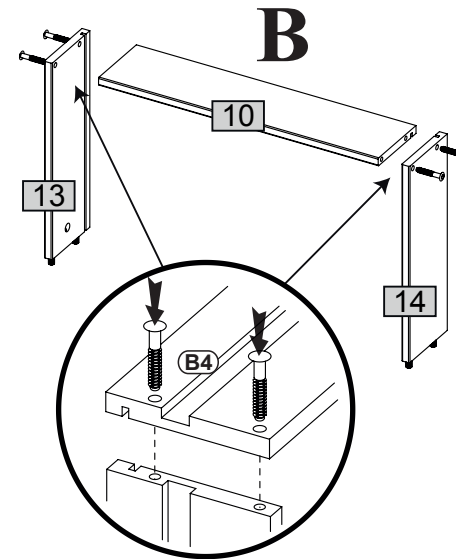

x2

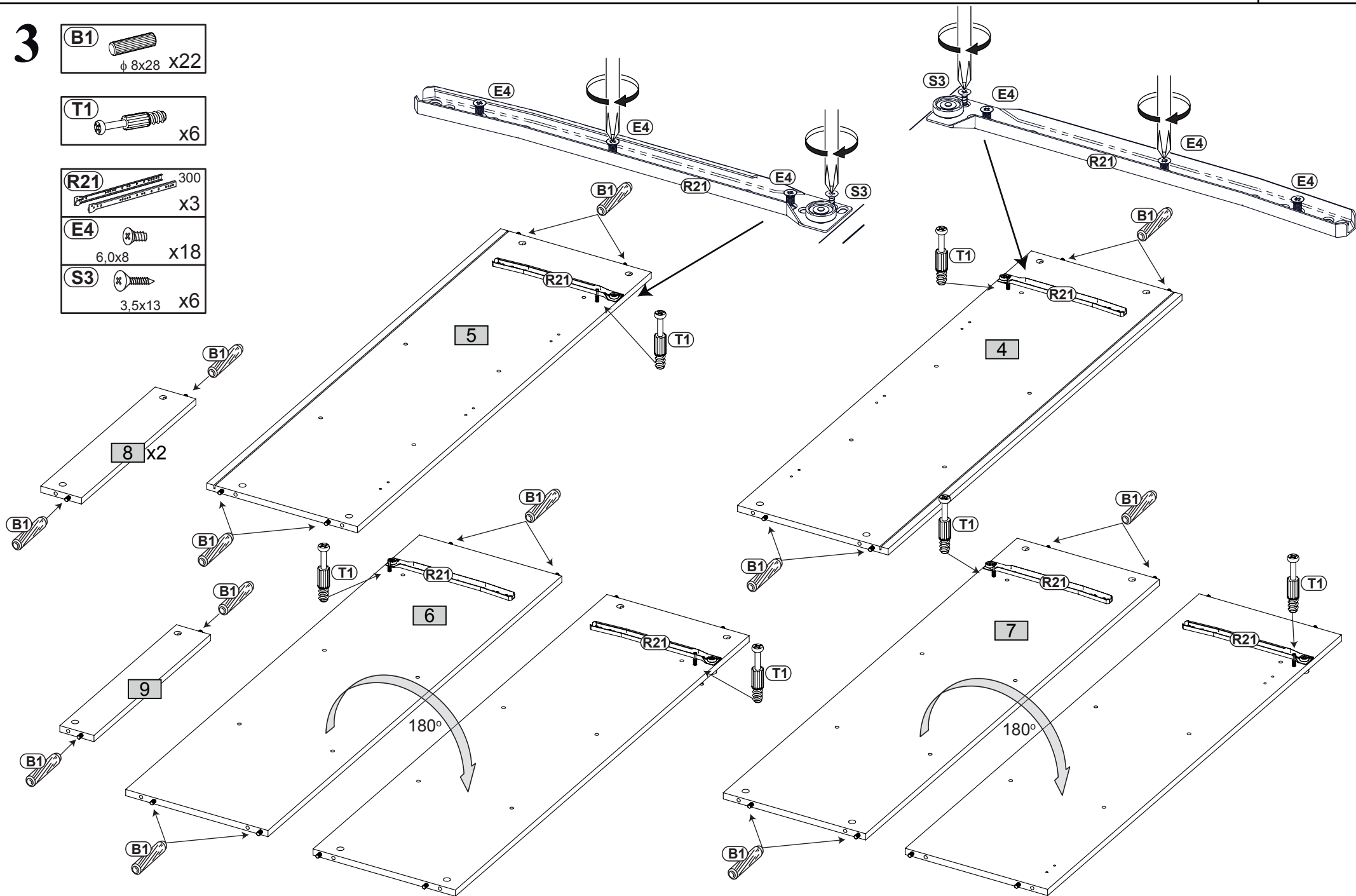
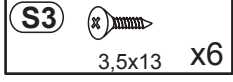
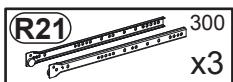
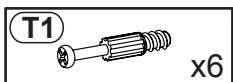
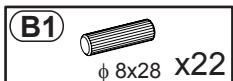

3





4

**F10**  x6  
**P17**  4x20 x6

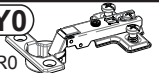
**T1**  x16

**Y0**  KR0 x6

**S8**  4x13 x12

**X9s**  x2

**P2**  3x16 x24

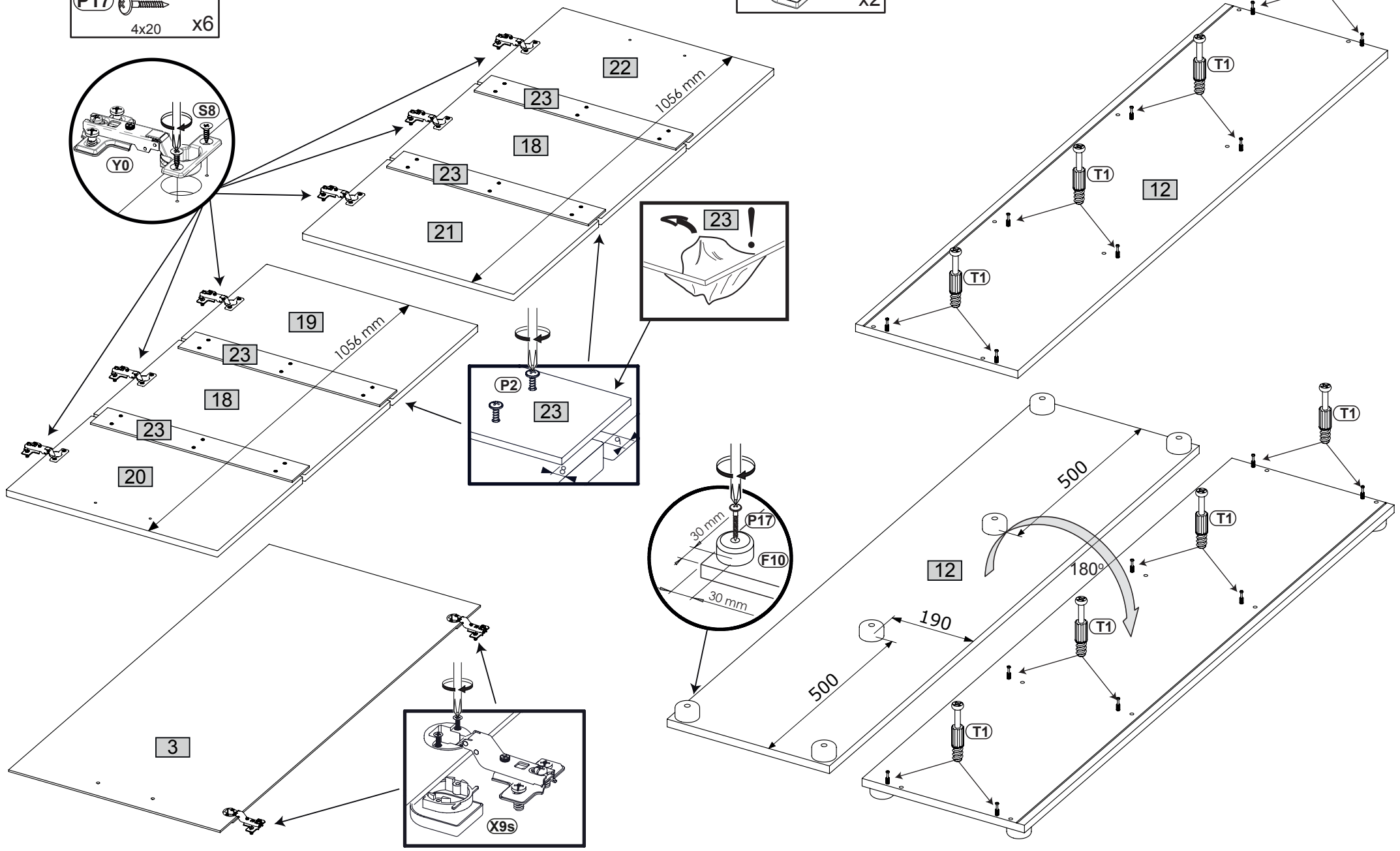

5

M1  x6

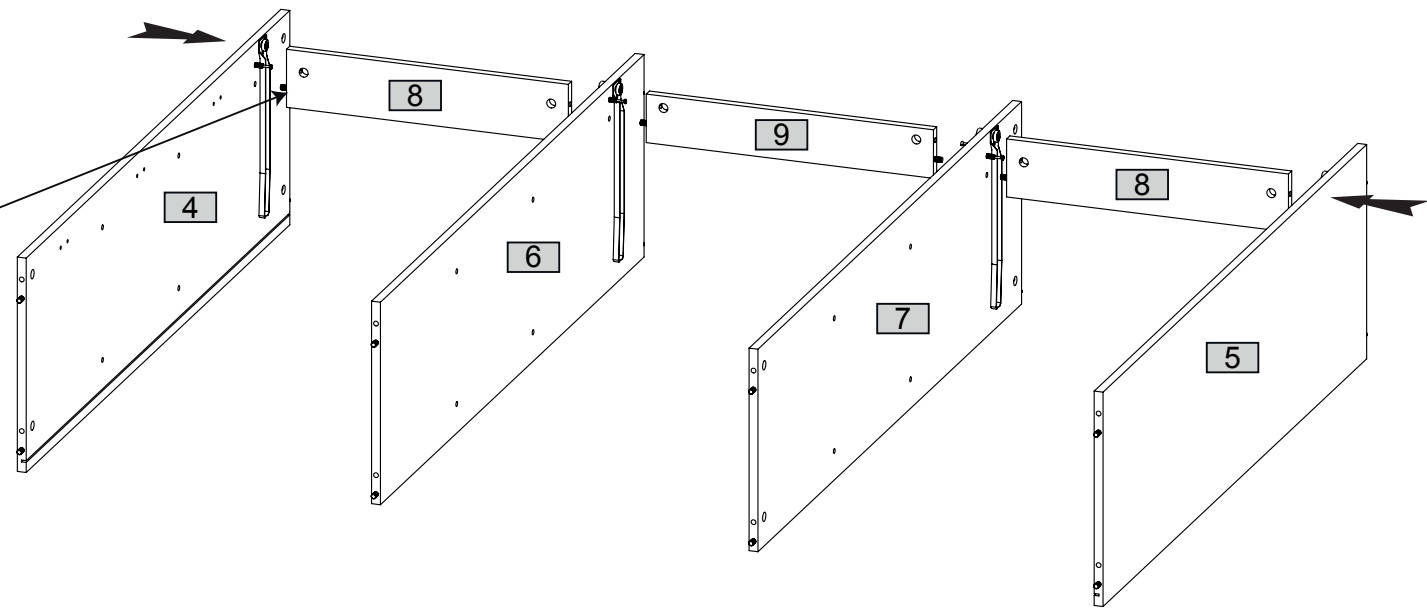
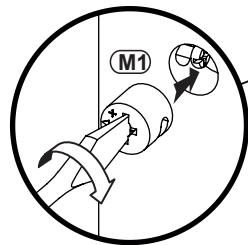



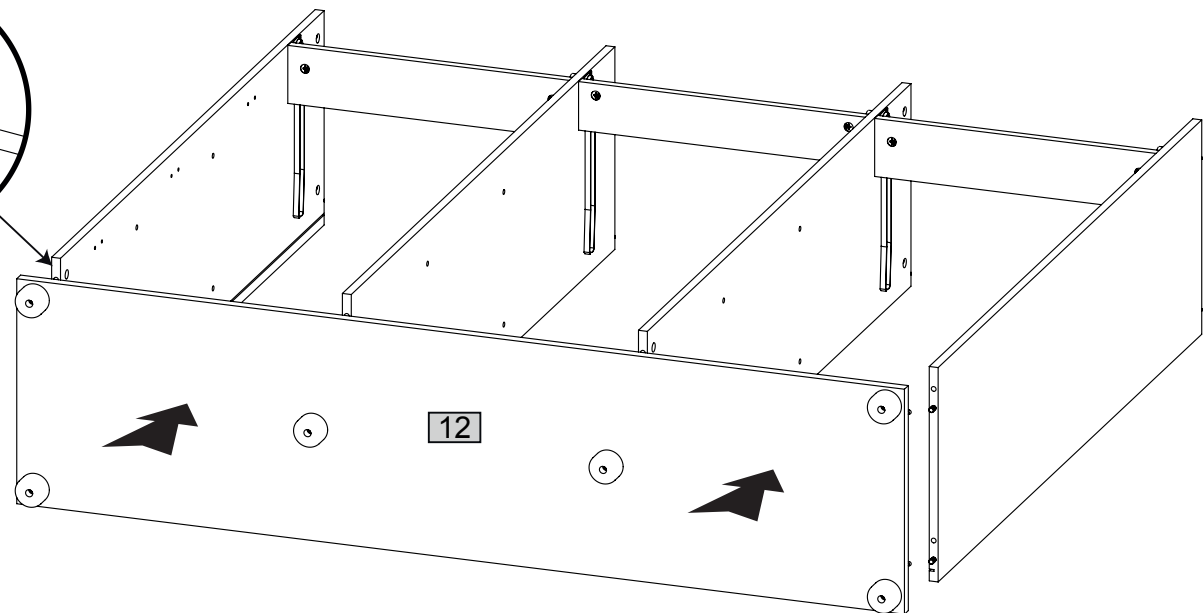
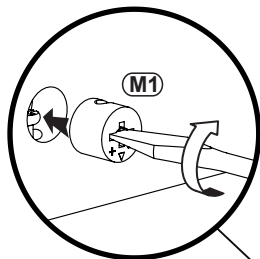

6

M1  x8

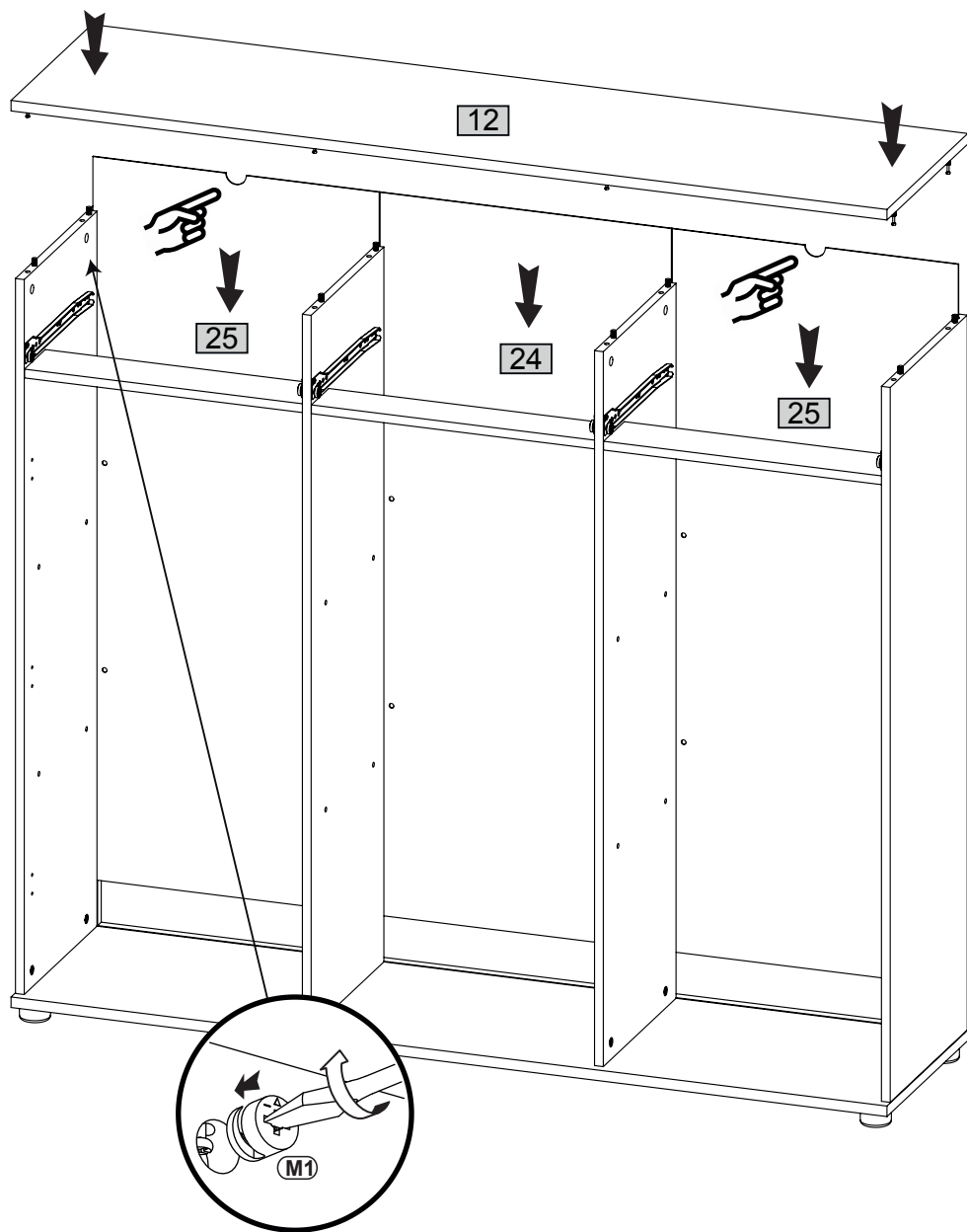

- 7** **M1**  x8



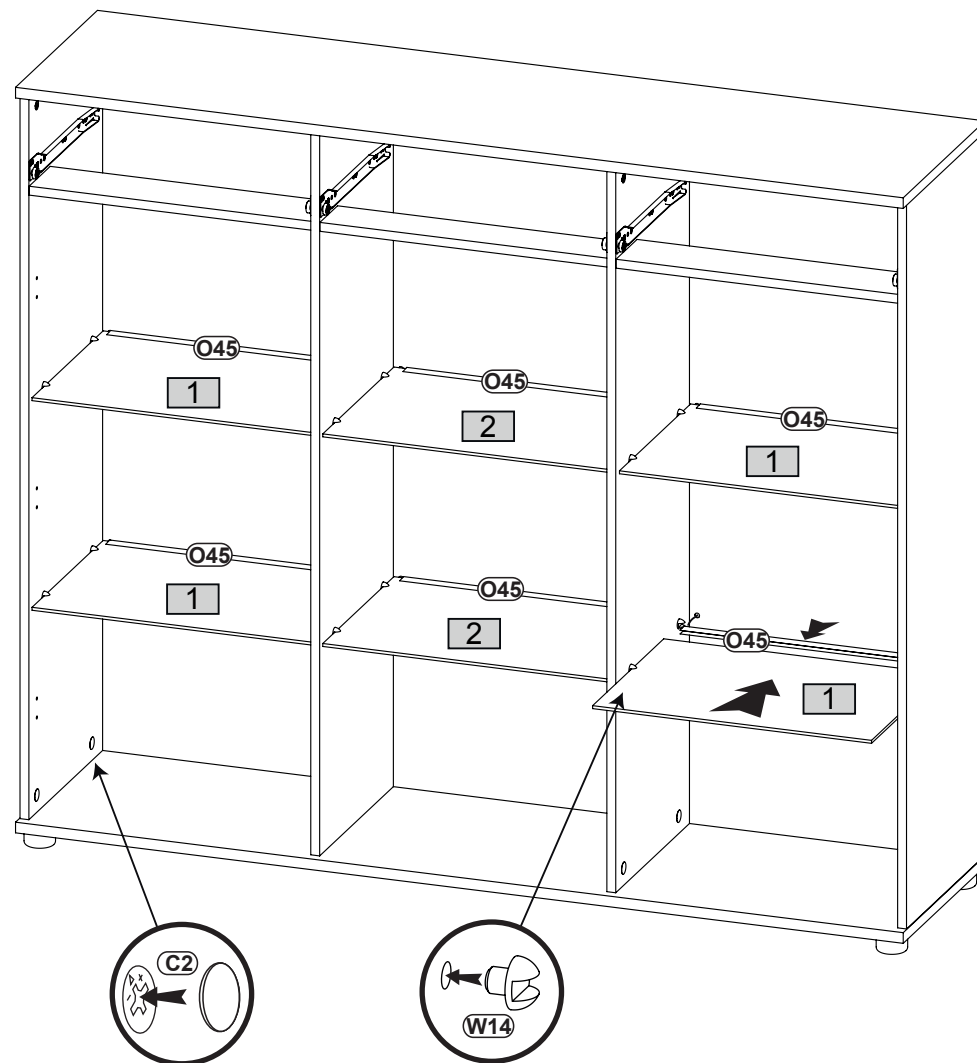

- 8** **W14**  x24 **C2**   $\phi 20$  x8 **O45**  x6





9

**F1**  x16

**P2**  3x16 x16

**J23**  x14

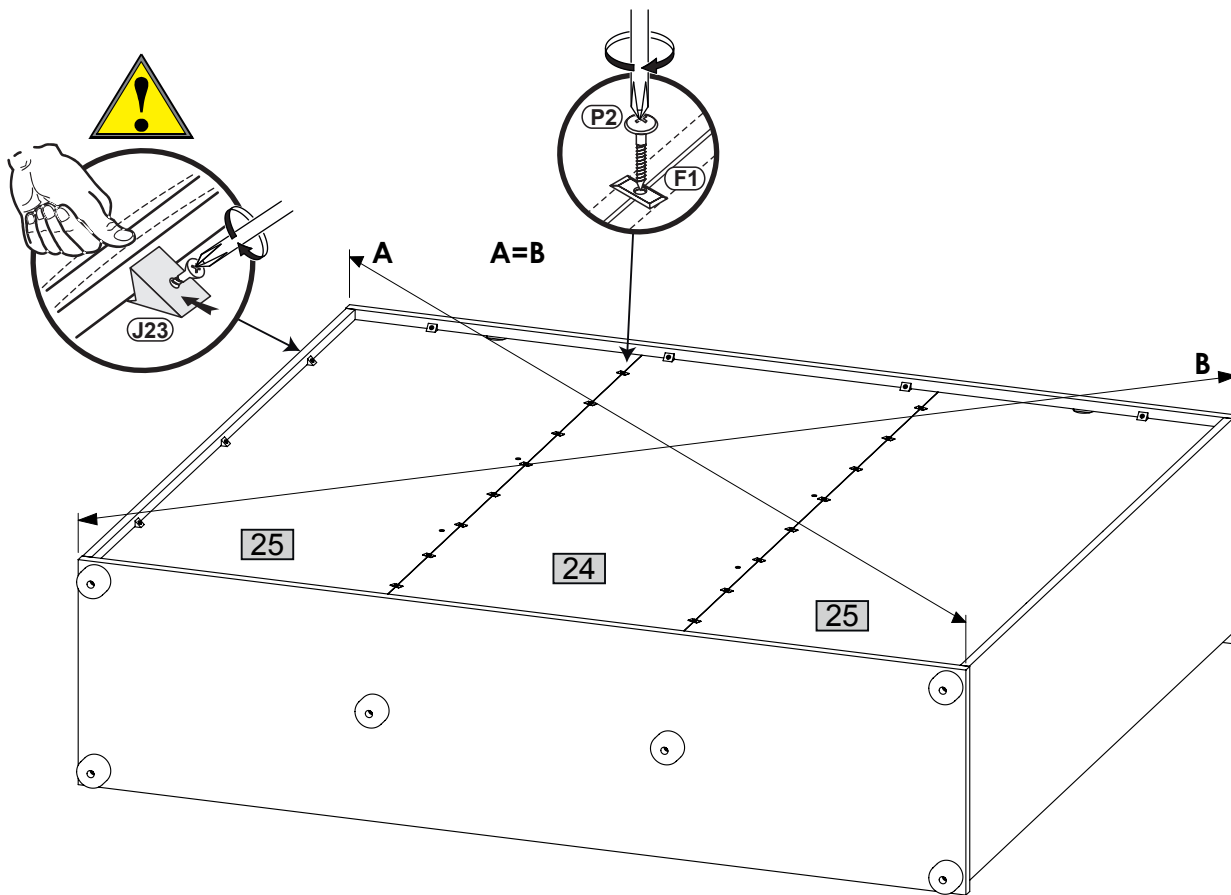

10

<b>U42b</b>		x6
<b>P4</b>		4x25 x10
<b>G4</b>		x2
<b>P16</b>		4x16 x2

<b>J11</b>		x2
<b>P13</b>		3,5x13 x4
<b>T17</b>		φ8x50 5x60 x2

